

小學普通畫學本

乙之部第三

文部省印行

官本三平編
明治三十一年六月

T1A1

70

Mi 77

小學普通畫學本乙之部第三

目錄

第四業

第一圖ハ幾何圖法ヲ示ス

第二圖ハ前同法單圖

第三圖ハ同法具ノ單圖



小學普通畫學本乙之部第三

第四業

第一圖

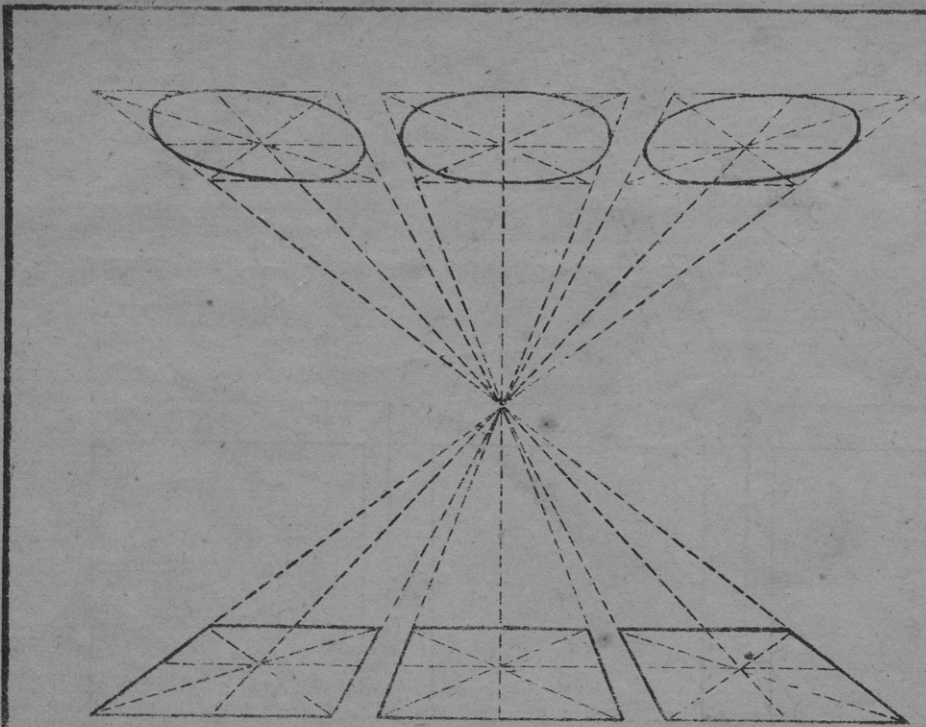

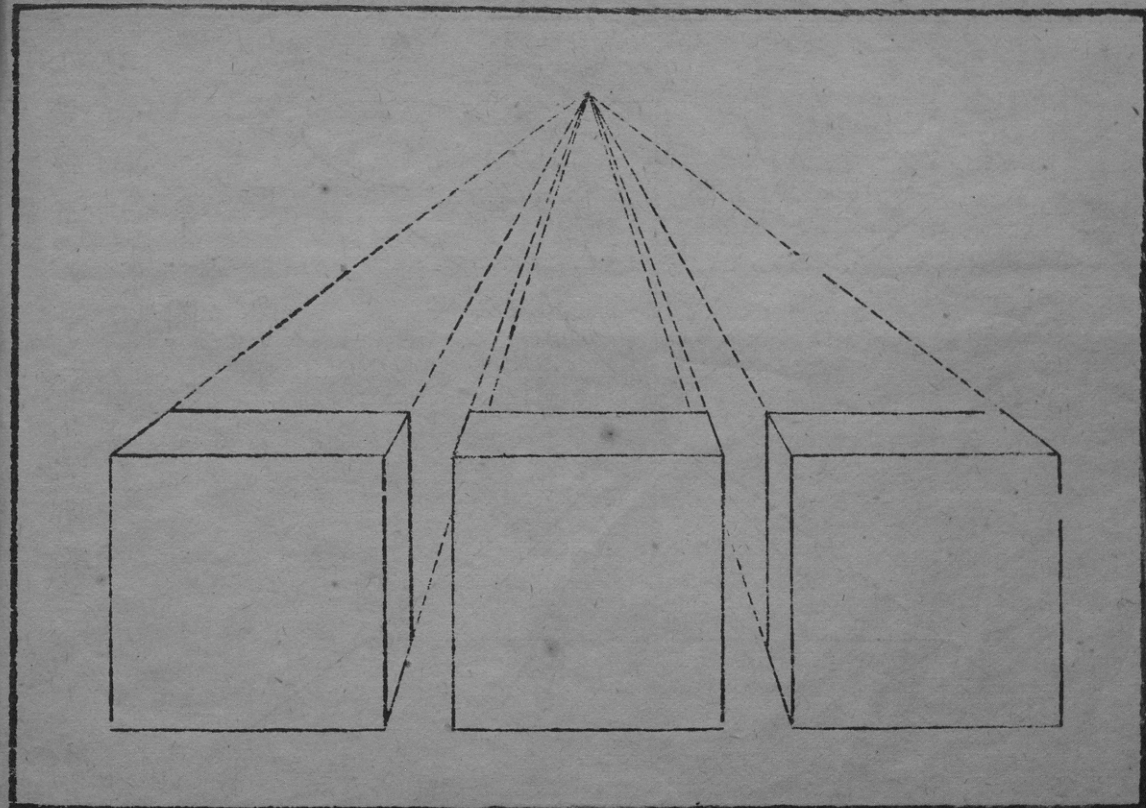
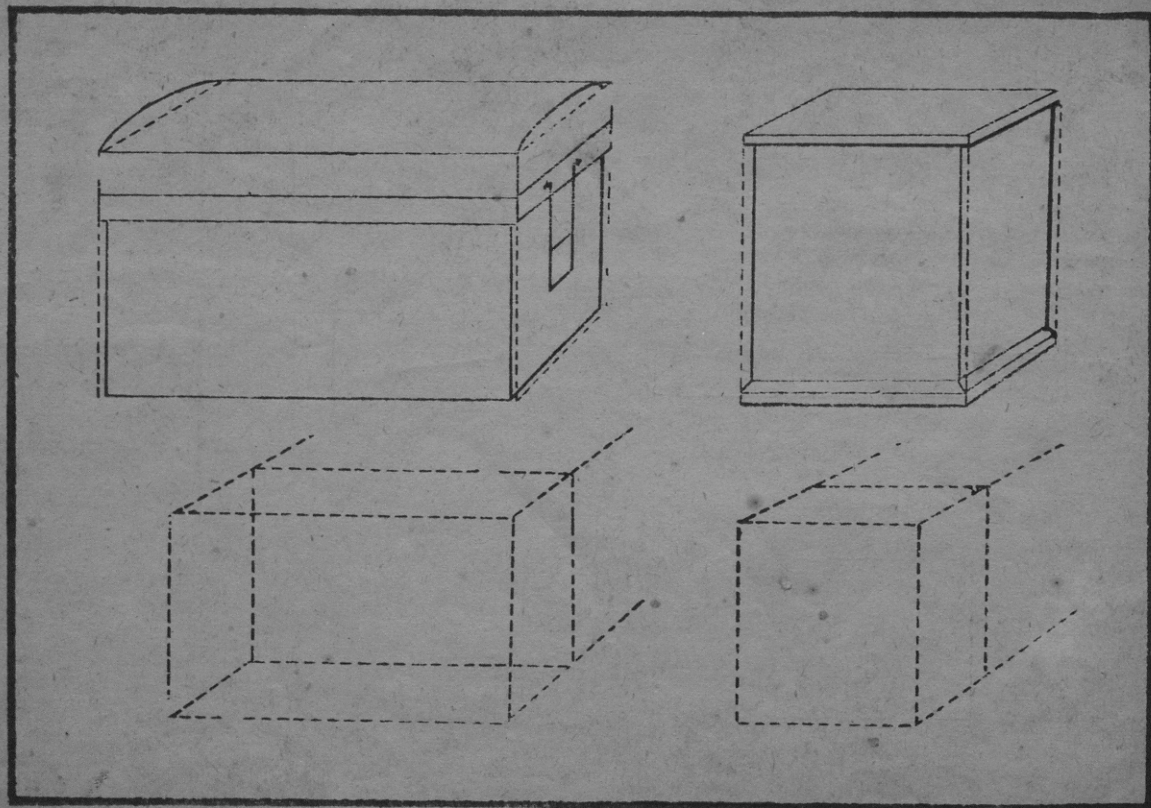

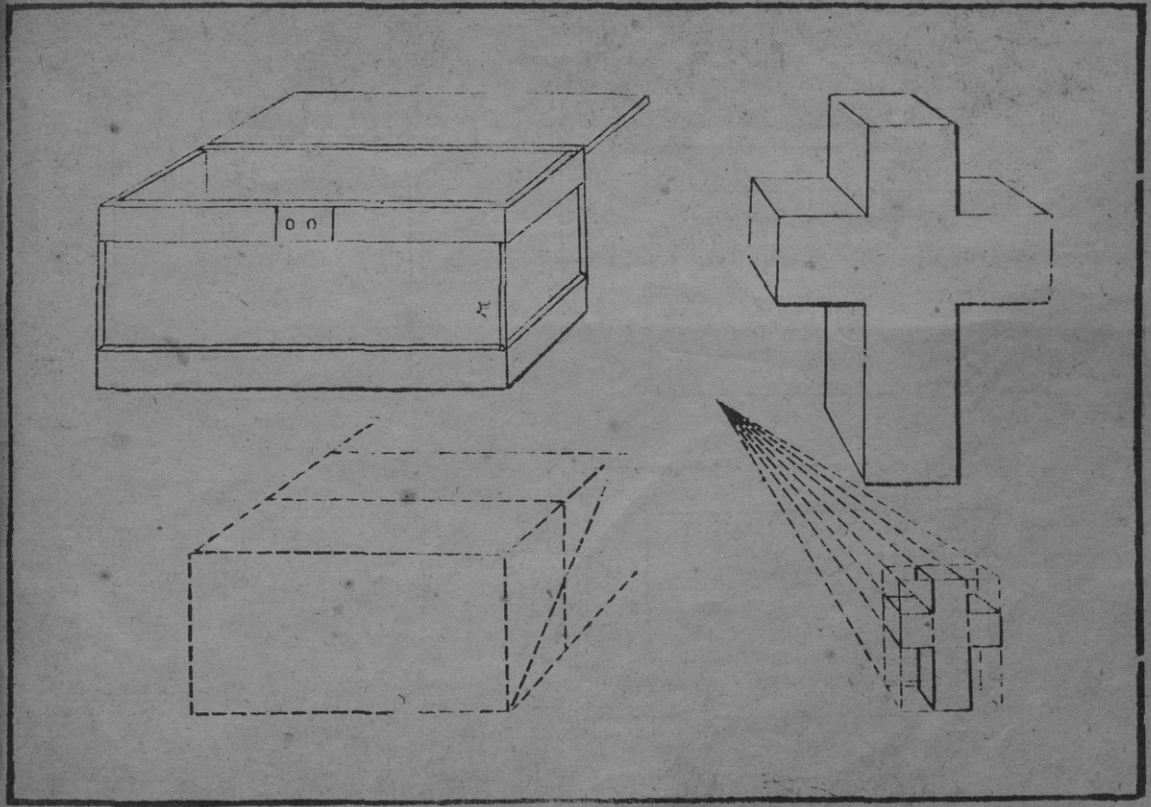
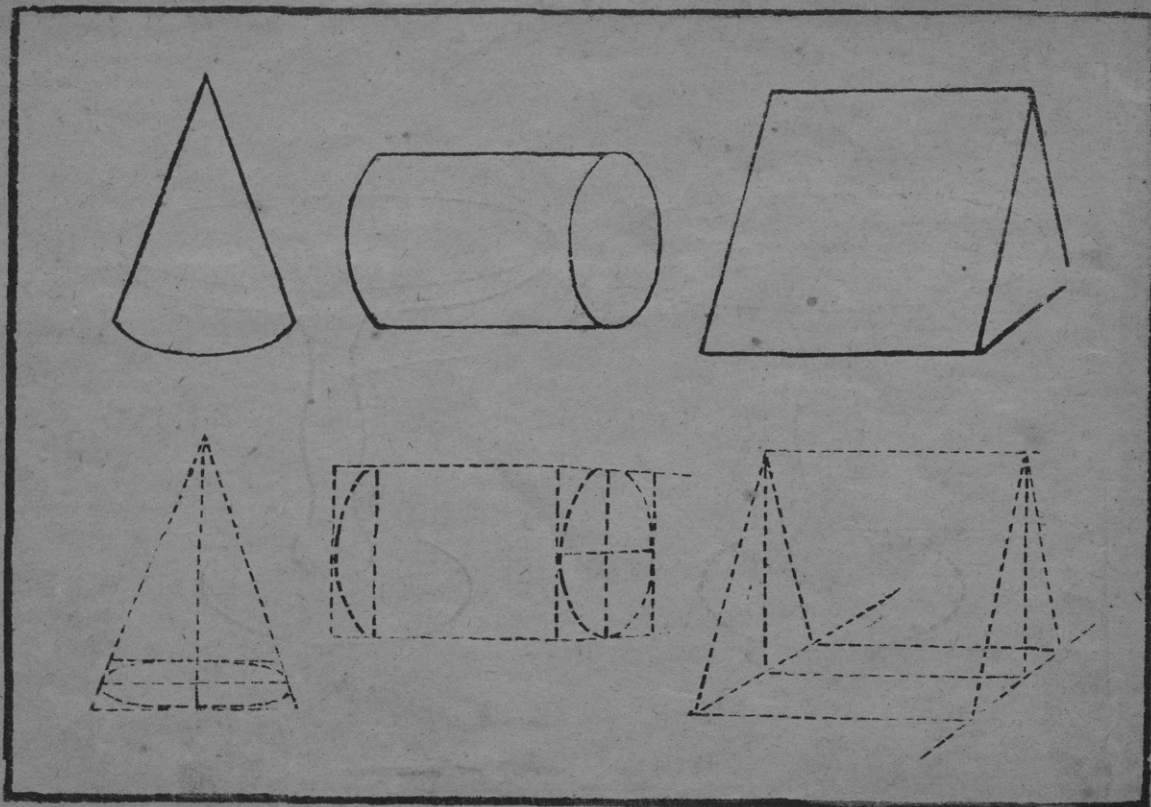

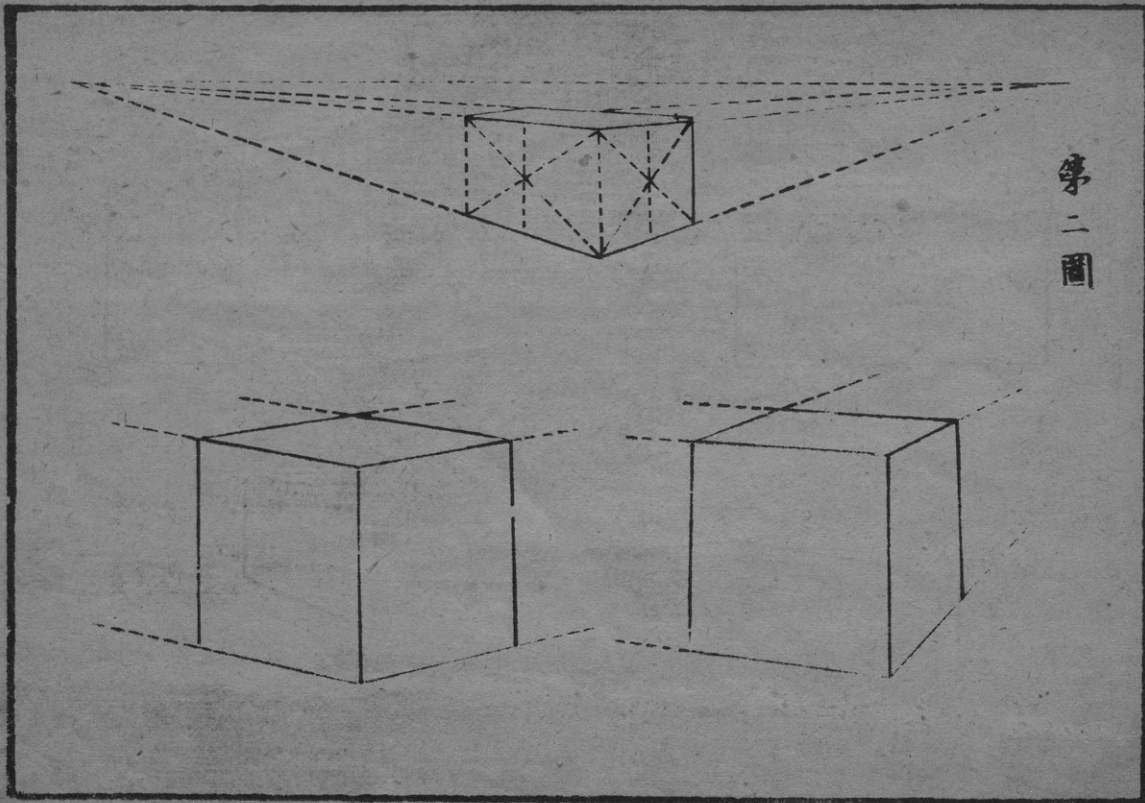

第二圖

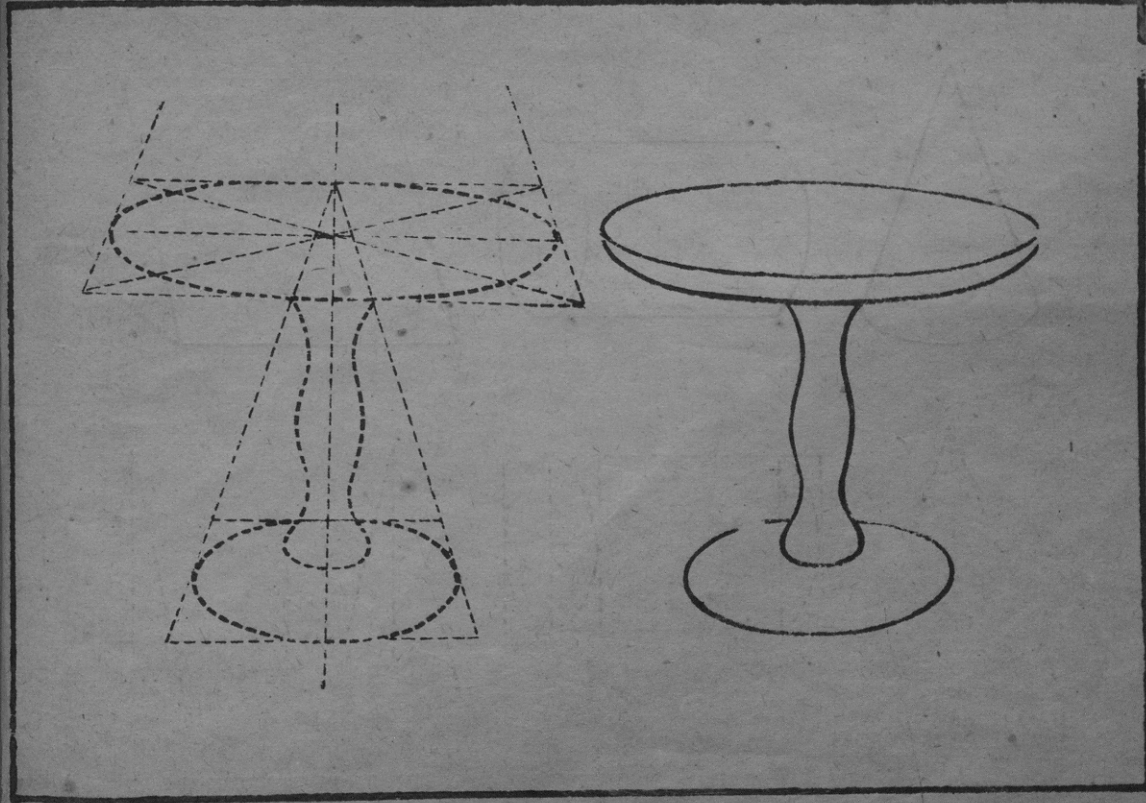

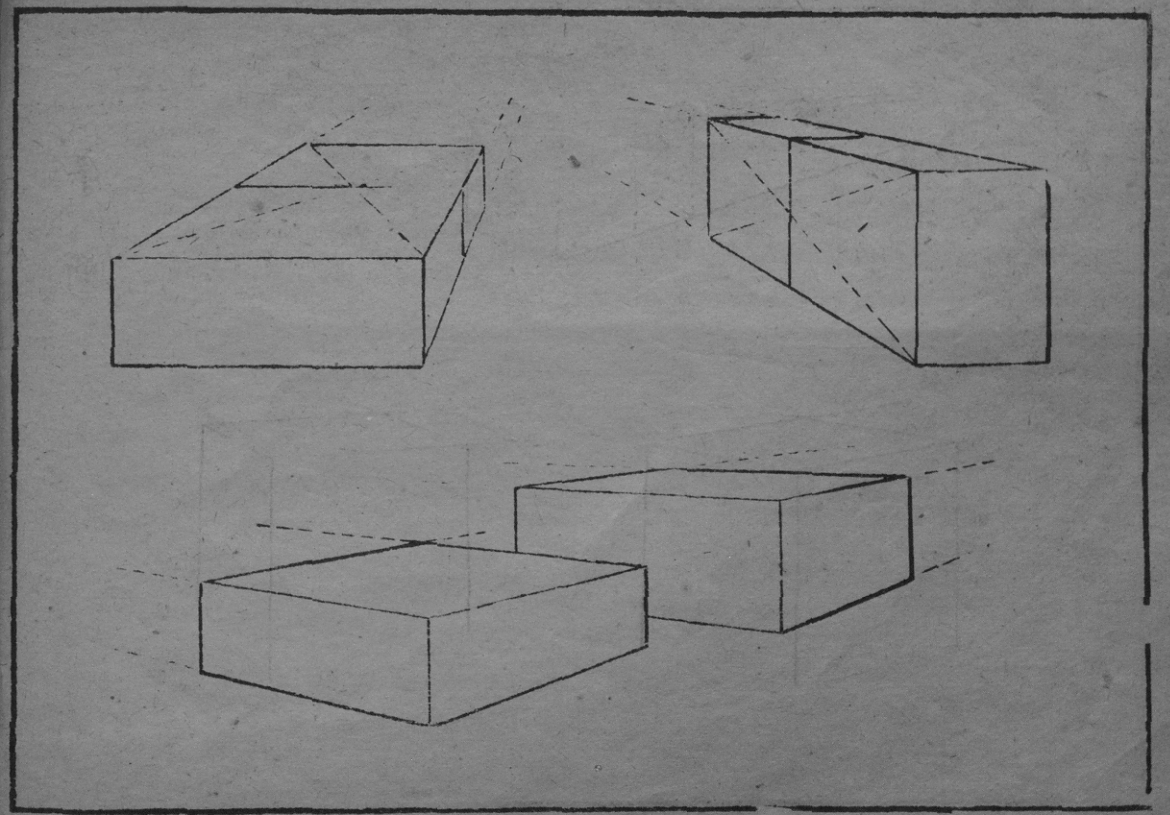
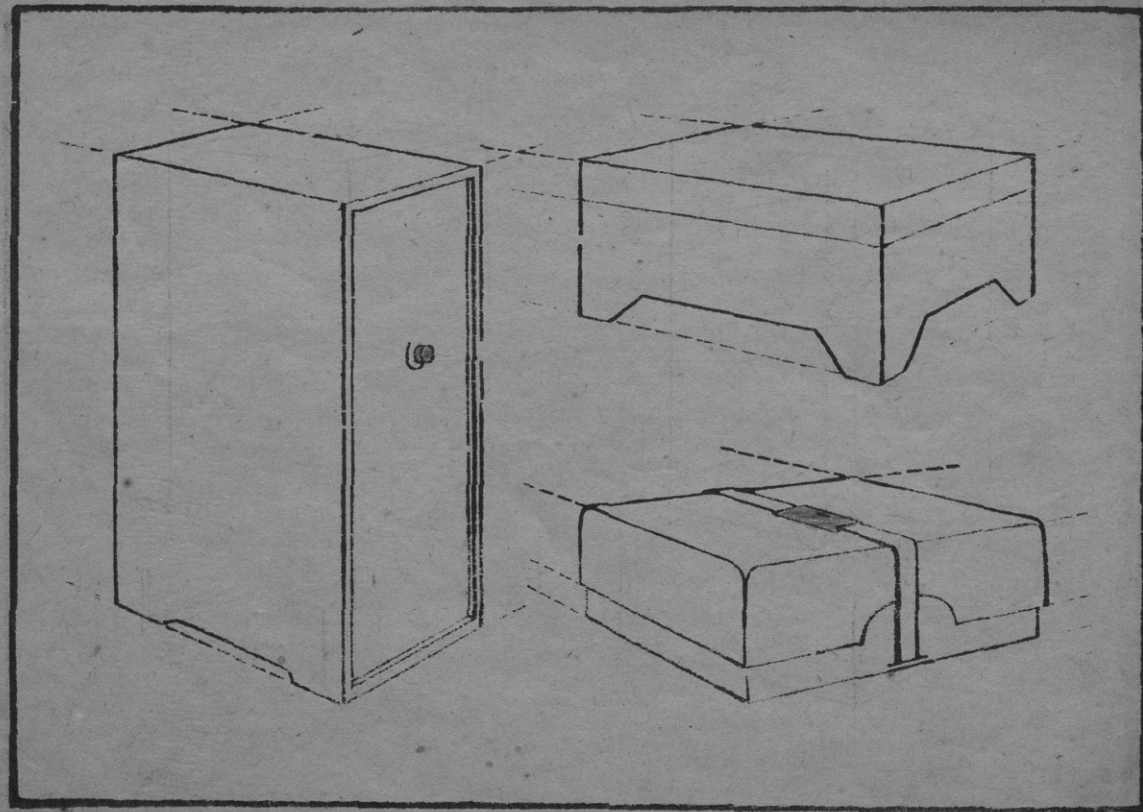

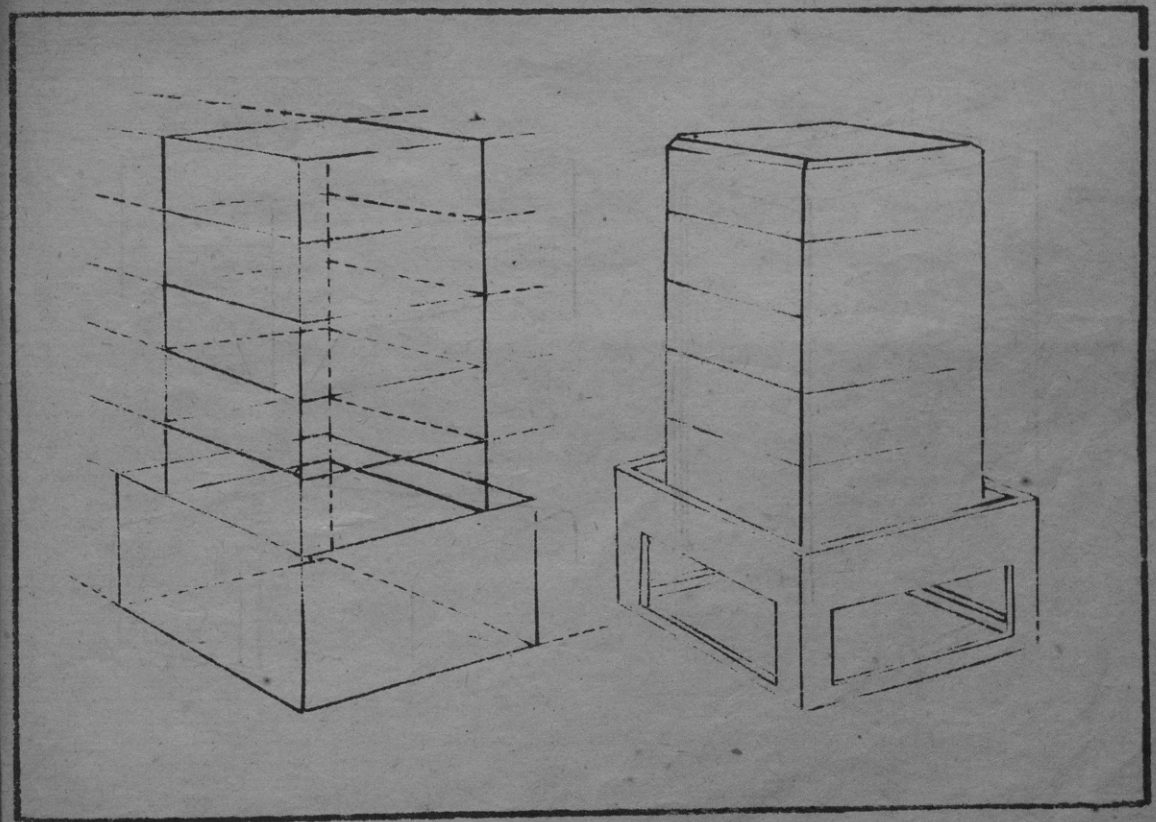
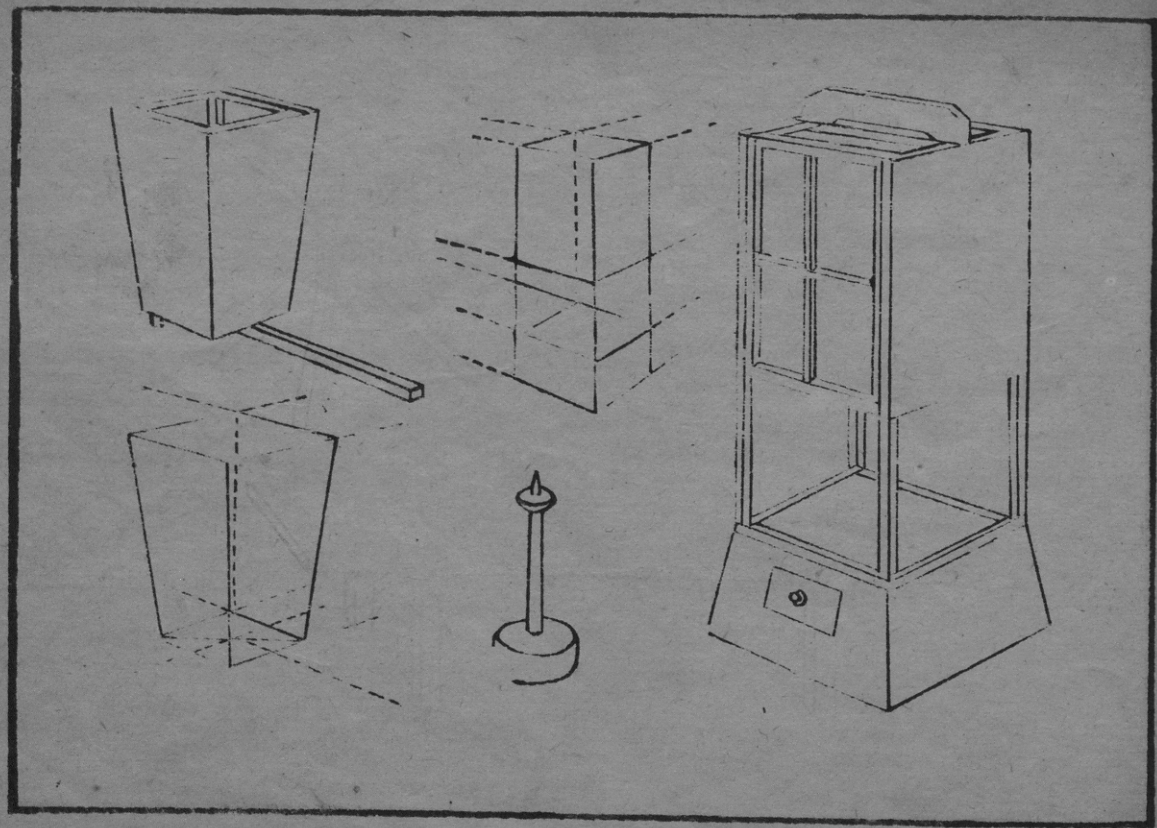

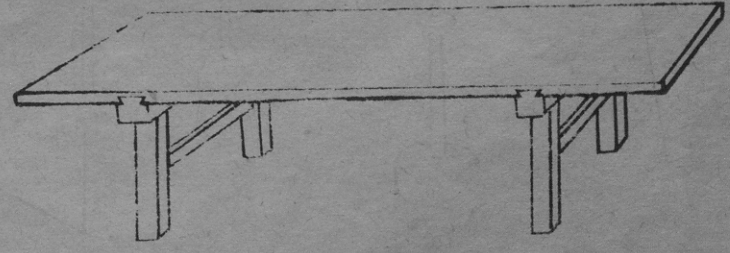
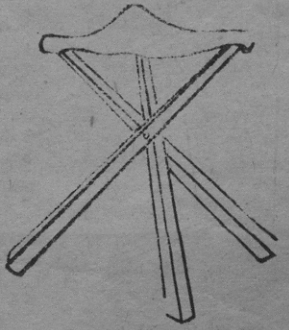
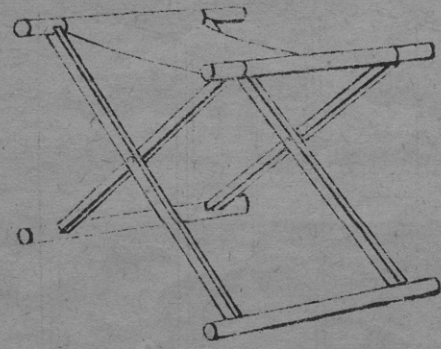
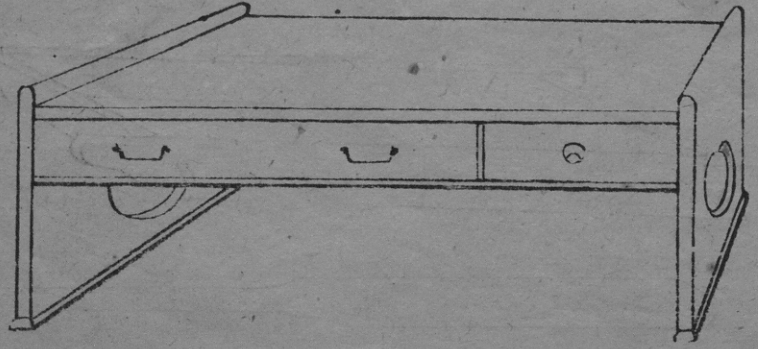
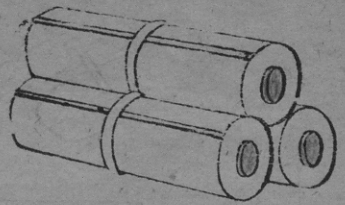
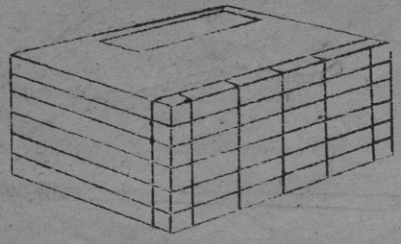

第三圖

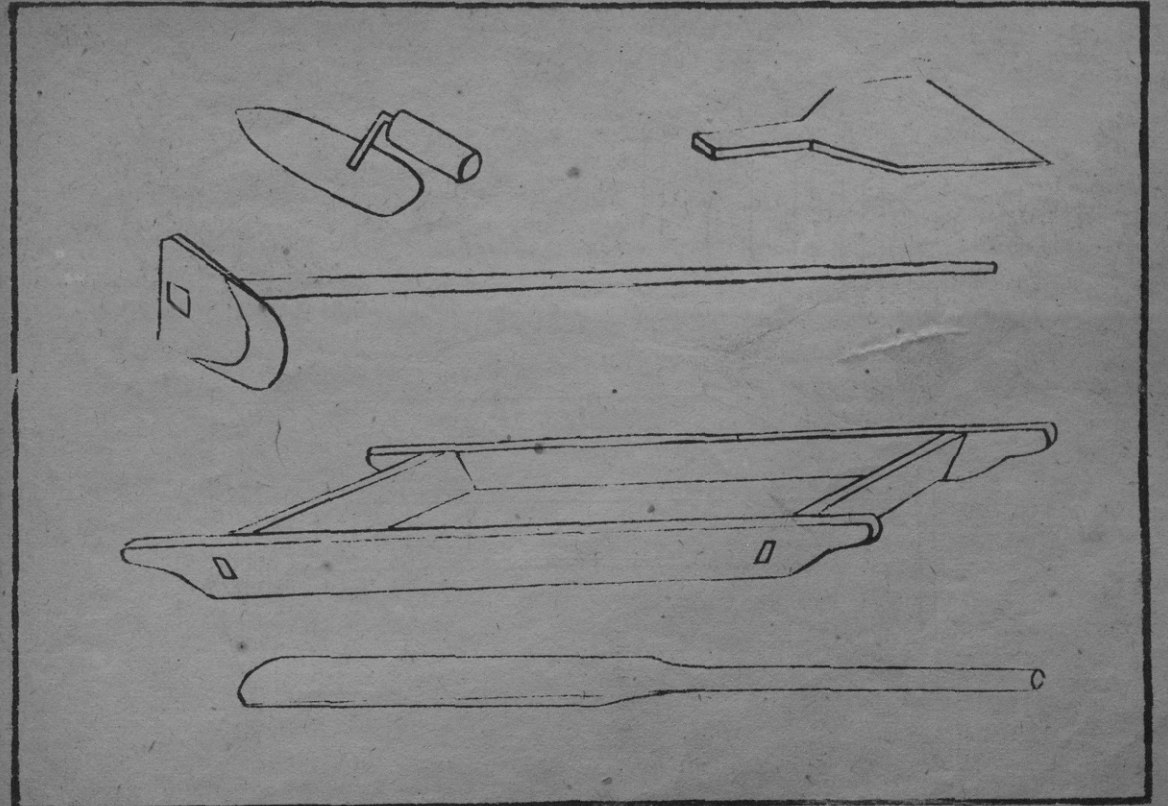
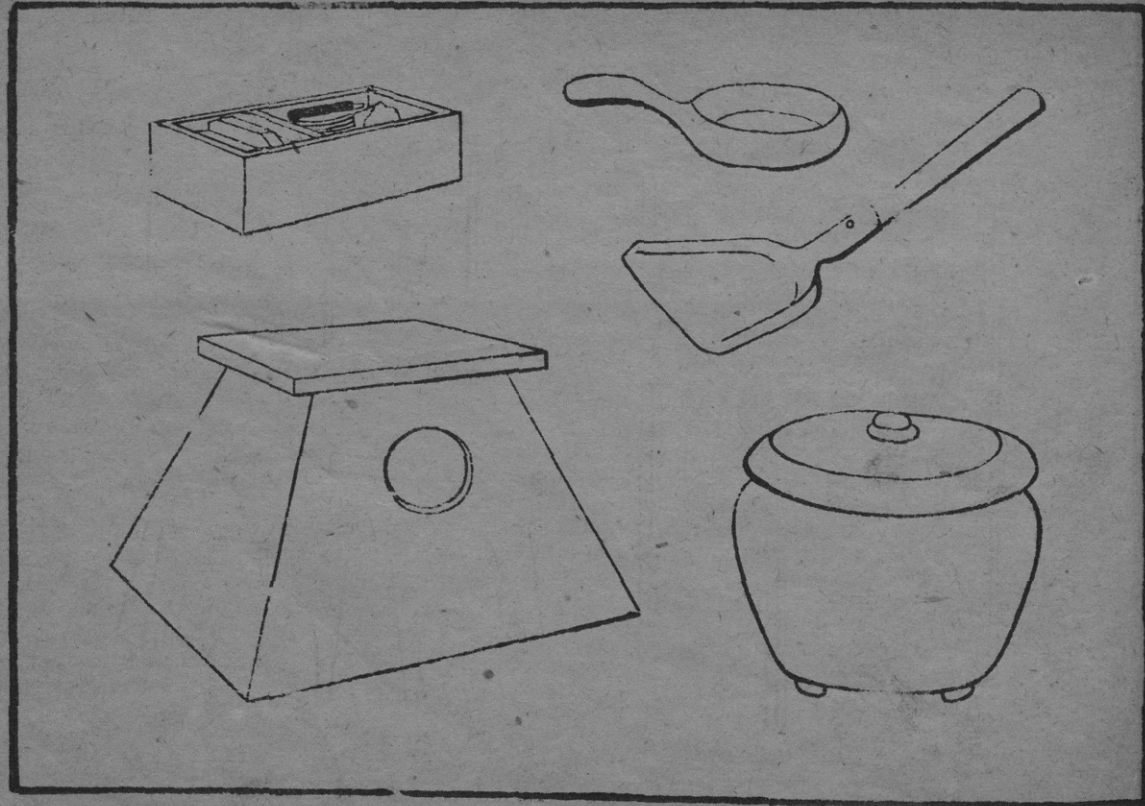

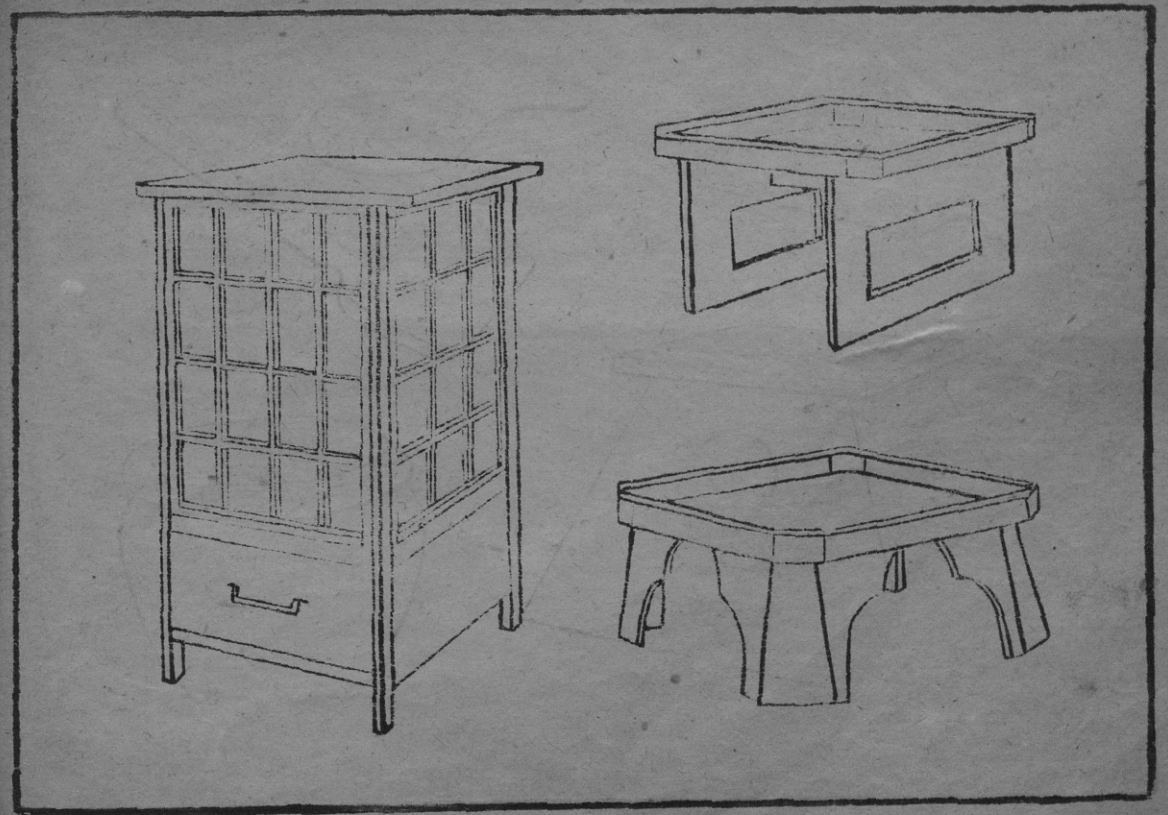
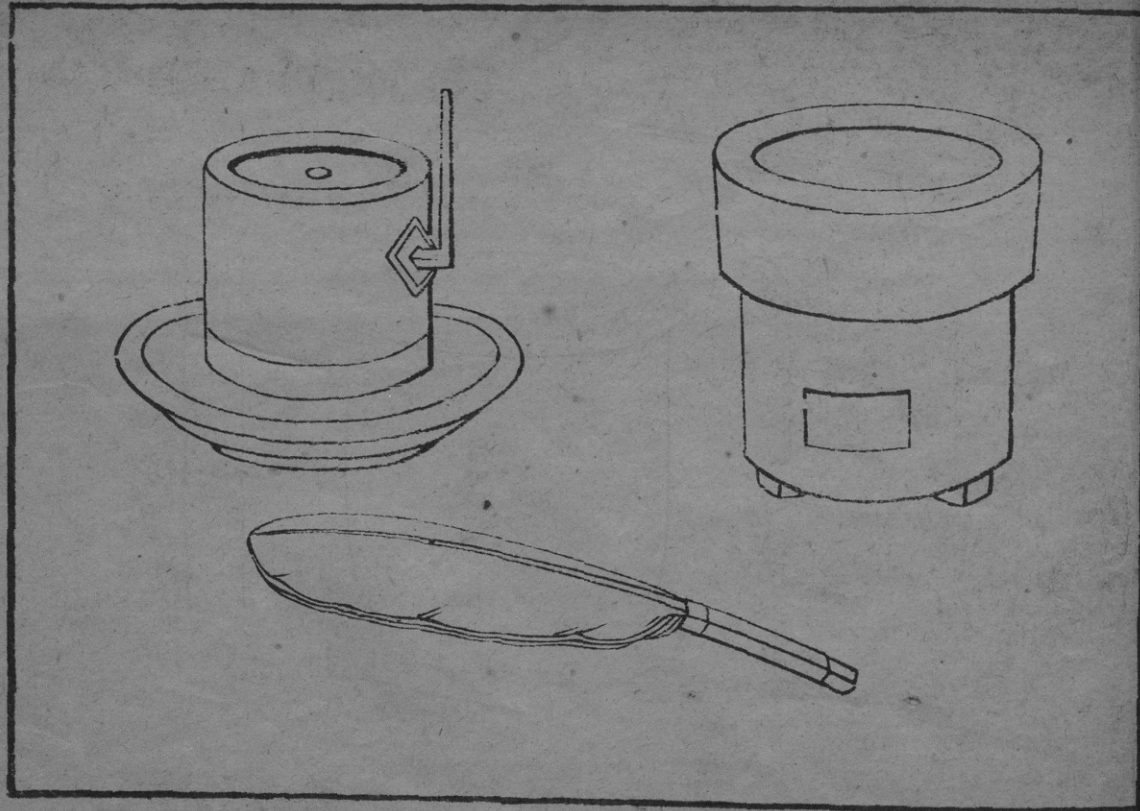

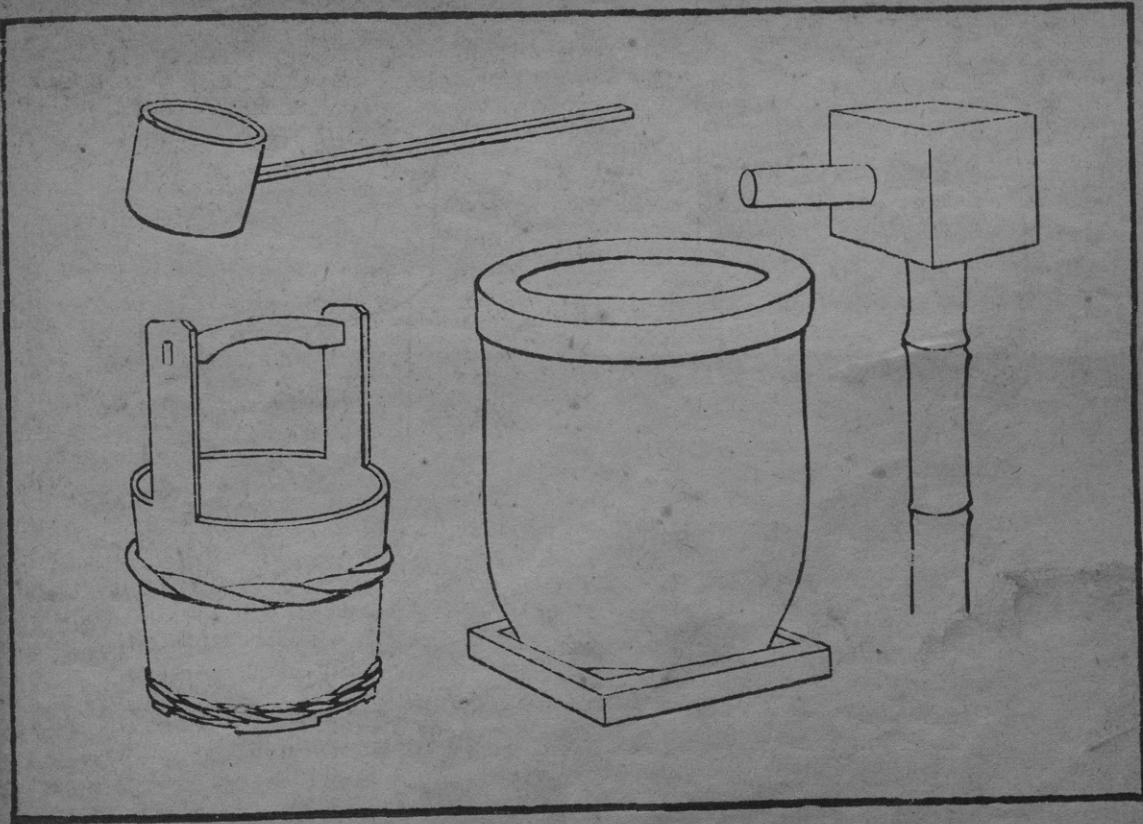
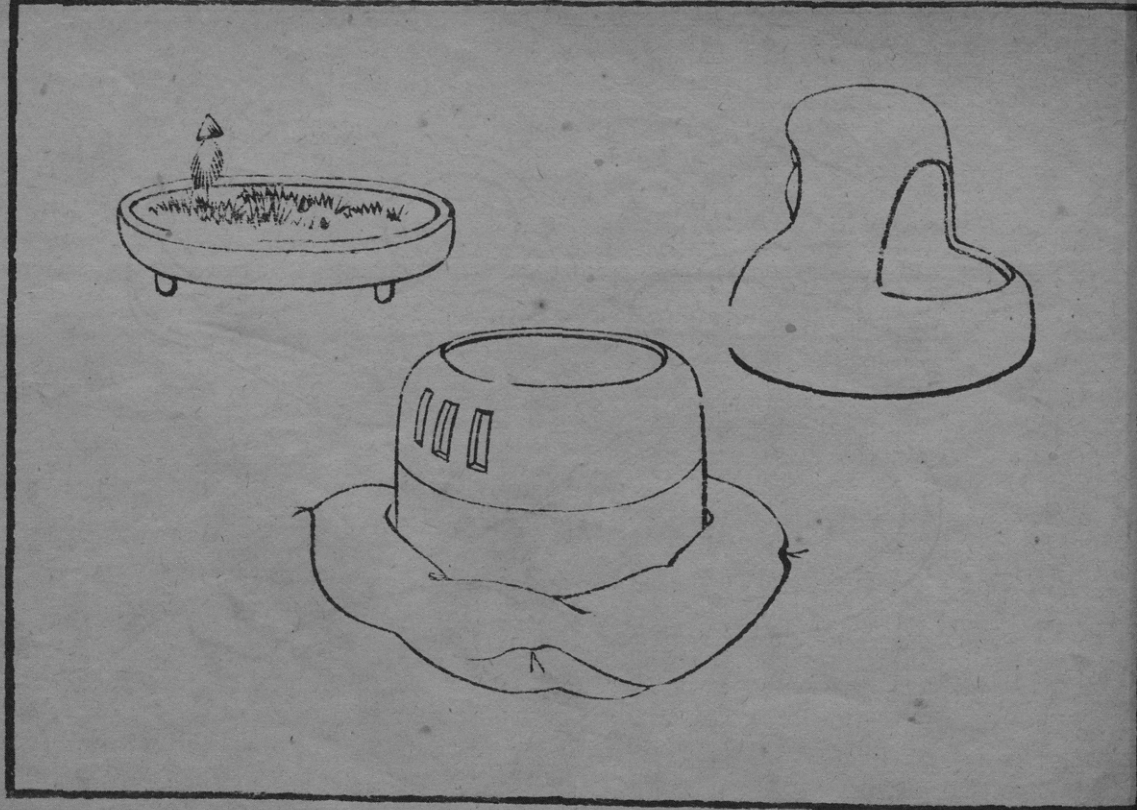

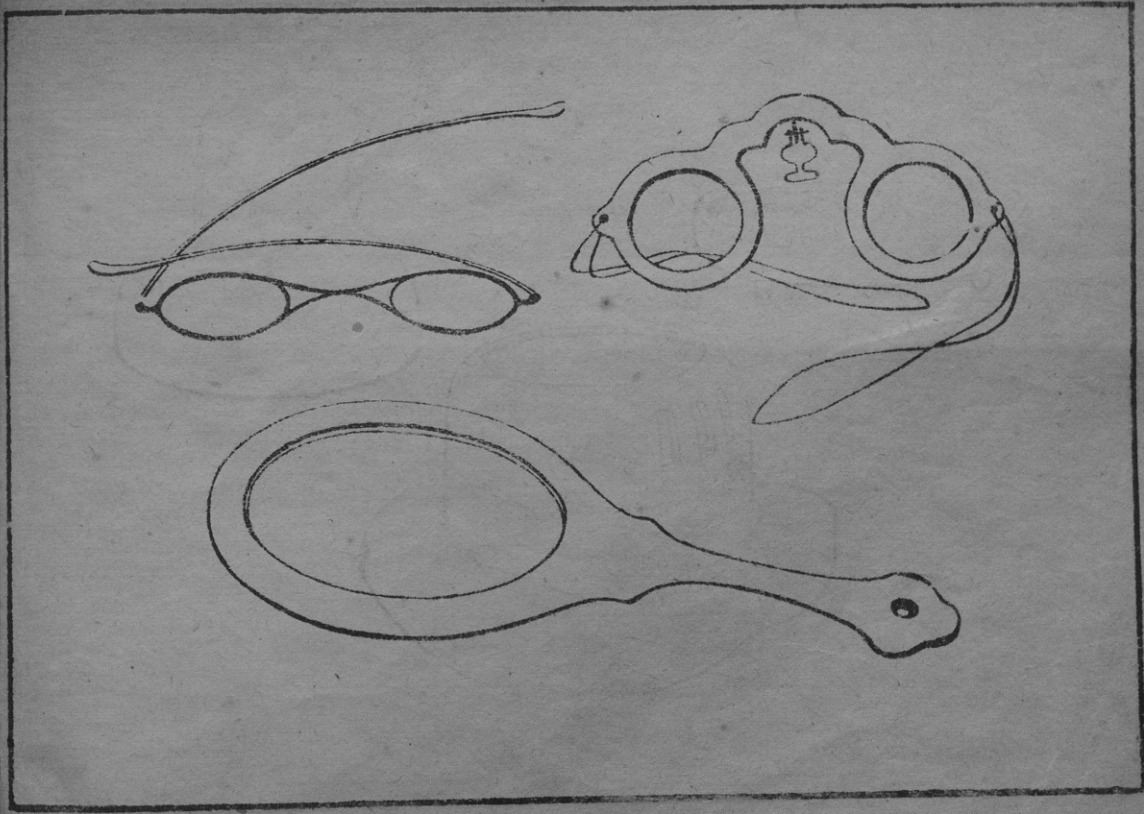

手
圖書 和圖書 遡



a 1380817346 a

福岡教育大学蔵書